

FEATURES OF THE SWITCH

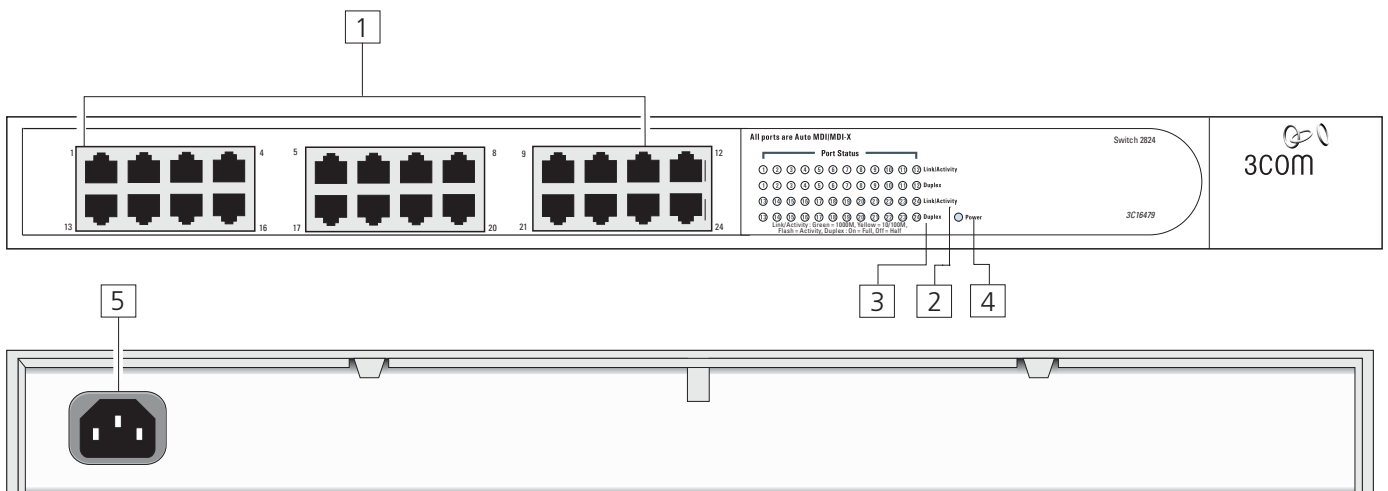

The numbers in this diagram refer to numbered sections in the text. A 24-port unit is shown.

Front Panel

1 24 RJ-45 10/100/1000 Ports



WARNING: RJ-45 ports. These are shielded RJ-45 data sockets. They cannot be used as standard traditional telephone sockets, or to connect the unit to a traditional PBX or public telephone network. Only connect RJ-45 data connectors, network telephony systems, or network telephones to these sockets. Either shielded or unshielded data cables with shielded or unshielded jacks can be connected to these data sockets.



AVERTISSEMENT: Les ports RJ-45. Ceux-ci sont protégés par des prises de données. Ils ne peuvent pas être utilisés comme prises de téléphone conventionnelles standard, ni pour la connection de l'unité à un réseau téléphonique central privé ou public. Raccorder seulement connecteurs de données RJ-45, systèmes de réseaux de téléphonie ou téléphones de réseaux à ces prises. Il est possible de raccorder des câbles protégés ou non protégés avec des jacks protégés ou non protégés à ces prises de données.



WARNUNG: RJ-45-Porte. Diese Porte sind geschützte Datensteckdosen. Sie dürfen weder wie normale traditionelle Telefonsteckdosen noch für die Verbindung der Einheit mit einem traditionellem privatem oder öffentlichem Telefonnetzwerk gebraucht werden. Nur RJ-45-Datenanschlüsse, Telefonnetzsysteme oder Netztelefone an diese Steckdosen anschließen. Entweder geschützte oder ungeschützte Buchsen dürfen an diese Datensteckdosen angeschlossen werden.

The Switch has 24/16 10/100/1000 Mbps auto-negotiating ports. Each port automatically negotiates with the attached device to determine the correct speed and duplex mode of operation. Once negotiated, the port will operate in one of the following modes:

- 10BASE-T half duplex
- 10BASE-T full duplex
- 100BASE-TX half duplex
- 100BASE-TX full duplex
- 1000BASE-T full duplex



CAUTION: The Switch supports full duplex auto-negotiation. If the connected device does not support auto-negotiation, the Switch will operate in half duplex mode, and therefore can only operate at 10 Mbps or 100 Mbps. In such a configuration, you may notice some degradation of network performance. 3Com recommends that you use devices that are capable of auto-negotiation (and that you ensure that auto-negotiation is enabled, if it is a configurable option).

All ports auto-sense an MDI/MDIX connection so each port can be connected to a device with a normal 'straight through' TP (twisted pair) cable or a 'cross-over' TP cable. Any port can therefore be used to connect to either another switch port, server, or workstation without additional configuration.

Traffic Prioritization

The Switch offers priority queuing, which means all packets that are received are examined to see if they have been priority encoded. When a packet is received, the Switch will read the priority level and determine the appropriate channel to forward the packet based on the priority level. This feature can be useful, for example, during excessive loads when one type of traffic may require priority over another. The Switch is configured to comply with 802.1p, VLAN tagged frames.

Traffic prioritization ensures that high priority data is forwarded through the Switch without being delayed by lower priority data. It differentiates traffic into classes and prioritizes those classes automatically. Traffic prioritization uses the multiple traffic queues that are present in the hardware of the Switch to ensure that high priority traffic is forwarded on a different queue from lower priority traffic, and is given preference over that traffic. This ensures that time-sensitive traffic gets the highest level of service. The 802.1D standard specifies eight distinct levels of priority (0 to 7), each of which relates to a particular type of traffic. The priority levels and their traffic types are shown in the following table.

Priority Level	Traffic Type
0	Best Effort
1	Background
2	Standard (spare)
3	Excellent Effort (business critical)
4	Controlled Load (streaming multimedia)
5	Video (Interactive media), less than 100 milliseconds latency and jitter.
6	Voice (Interactive voice), less than 10 milliseconds latency and jitter.
7	Network Control Reserved traffic

 The traffic prioritization feature supported by the Switch is compatible with the relevant sections of the IEEE 802.1D standard (incorporating IEEE 802.1p).

2 Activity/Link/Speed Status LEDs

The top and third row of Status LEDs, labelled “Link/Activity,” show the link and activity status of the related ports:

Status	Meaning
Green	The link is operating at 1000 Mbps.
Yellow	The link is operating at 10 or 100 Mbps.
Flashing	Packets are being received or transmitted on the port.
Off	The link has not been established, either nothing is connected to the port, or there is a problem: <ul style="list-style-type: none"> ■ Check that the attached device is powered on. ■ Check that the cable is the correct type and is not faulty. If these checks do not identify the cause of the problem, it may be that the unit or the device connected to the port is faulty. Contact your supplier for further advice.

3 Duplex Status LEDs

The second and fourth row of Status LEDs, which are colored yellow, show the duplex status of the related ports:

Status	Meaning
Yellow	The port is operating in full duplex mode.
Off	The port is operating in half duplex mode.

 1000BASE-T only operates in full duplex mode. 10BASE-T/100BASE-TX can be in half or full duplex mode.

4 Power LED

The Power LED shows the power status of the Switch:

Status	Meaning
Green	The unit is powered on and ready for use.
Off	<ul style="list-style-type: none"> ■ The unit is not receiving power: ■ Check that the power cord is connected correctly. ■ If the unit still does not operate, contact your supplier.

Rear Panel Connections

5 Power Supply

The Switch automatically adjusts to the supply voltage. Only use the power cord that is supplied with the unit.

INSTALLING THE SWITCH

Positioning the Switch

When deciding where to position the Switch ensure:

- It is accessible and cables can be connected easily.
- Cabling is away from sources of electrical noise. These include lift shafts, microwave ovens, and air conditioning units. Electromagnetic fields can interfere with the signals on copper cabling and introduce errors, therefore slowing down your network.
- Water or moisture cannot enter the case of the unit.
- Air flow around the unit and through the vents in the side of the case is not restricted (3Com recommends that you provide a minimum of 25 mm (1 in.) clearance).
- The air is as free from dust as possible.
- Temperature operating limits are not likely to be exceeded. It is recommended that the unit is installed in a clean, air conditioned environment.

 It is always a good practice to wear an anti-static wrist strap when installing network equipment, connected to a ground point. If one is not available, try to keep in contact with a grounded rack and avoid touching the unit's ports and connectors, if possible. Static discharge can cause reliability problems in your equipment.

Rack Mounting or Free Standing

This unit can be mounted in a 19-inch equipment rack using the Mounting Kit. Refer to “Mounting Kit Instructions” on page 4. It can also be free standing. Do not place objects on top of the unit or stack.

The unit is supplied with four self-adhesive rubber pads. If the unit is to be part of a free standing stack, apply the pads to each marked corner area on the underside of the unit. Place the unit on top of the lower unit, ensuring that the pads locate with the recesses of the lower unit.

 Do not apply the pads if you intend to rack mount the unit.

 **CAUTION:** If installing the Switch in a free standing stack of different sized units, the smaller units must be installed above the larger ones. Do not build a free standing stack of more than six units.

Connecting to a Network Device

Follow these guidelines to connect a device to the Switch:

- Use Category 5 unshielded or shielded (screened) 100 Ohm TP cable (or Category 3 cable for a 10 Mbps connection). 3Com recommends using Category 5E cable for 1000BASE-T operation.
- The maximum length of cable for each connection is 100 m (328 ft).
- Connect one end of the cable to an RJ-45 port on the Switch, and the other end to the appropriate RJ-45 port on the connecting device.

Power Supply

Power problems can be the cause of serious failures and downtime in your network. Ensure that the power input to your

system is clean and free from sags and surges to avoid unforeseen network outages. 3Com recommends that you install power conditioning, especially in areas prone to black outs, power dips and electrical storms.

Powering Up

Use the following sequence to power up the Switch:

- 1 Check the network connections and cables.
- 2 Connect the power supply cable to the appropriate power socket located on the rear panel of the unit.
- 3 Connect the plug to the power supply outlet socket and switch on the power supply at the socket.

When the switch is powered on, the Power LED lights green. If it does not, see reference **4** in "Features of the Switch" on page 3.

MOUNTING KIT INSTRUCTIONS

Introduction

The Switch is supplied with two mounting brackets and four screws. These are used for rack mounting the unit. When mounting the unit, you should take note of the guidelines given in "Positioning the Switch" on page 3.

Rack Mounting the Units

The Switch is 1U high and will fit a standard 19-inch rack.



CAUTION: Disconnect all cables from the unit before continuing. Remove the self-adhesive pads from the underside of the unit, if already fitted.

- 1 Place the unit the right way up on a hard, flat surface with the front facing towards you.
- 2 Locate a mounting bracket over the mounting holes on one side of the unit (refer to the figure following step 6).

- 3 Insert the two screws supplied in the mounting kit and fully tighten with a suitable screwdriver.
- 4 Repeat the two previous steps for the other side of the unit.
- 5 Insert the unit into the 19-inch rack and secure with suitable screws (not provided).
- 6 Reconnect all cables.

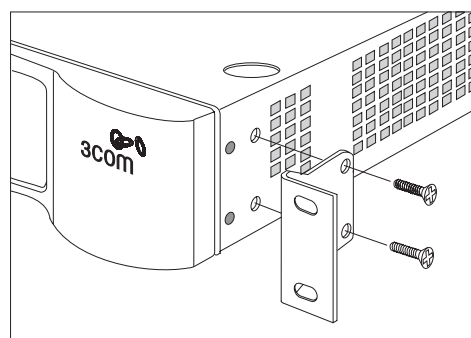

PROBLEM SOLVING

At frequent intervals you should visually check the Switch. Regular checks can give you an early warning of a possible failure; any problems can then be attended to when there will be least effect on users.

Check that all external cabling connections are secure and that no cables are pulled taut.

Refer to the information about LEDs given earlier in this guide to see if the problem can be identified and solved. Here are some common problems that can occur:

Activity Status LED not lit for a port that has a connection. There is a problem with this connection. Check that:

- The device being connected to is powered on and operating correctly.
- The cable is connected at both ends.
- You are using a TP cable that is not damaged.
- If the connection is to a workstation, that the workstation's network interface card is installed and configured correctly.

All Activity LEDs appear to be lit continually. There may be broadcast storms on the network. Remove port connections one at a time, waiting a few seconds between each port. If the LEDs go off after removing a port connection, the device that was connected to that port is introducing an excessive amount of broadcast frames to the network (some pieces of network equipment operate by sending out broadcast frames regularly). Refer to the documentation that accompanies the device for information on disabling the broadcast operation.

If the problem persists and the unit still does not operate successfully, contact your supplier with the following information before returning the unit:

- Product number and serial number (printed on a label supplied with the unit)
- A brief description of the fault condition

SAFETY INFORMATION

Please read the following safety information carefully before installing the Switch.



WARNING: Installation and removal of the unit must be carried out by qualified personnel only.

- If installing Switch 2824/Switch 2816 in a stack with other 3Com Hub or Switch units, larger units must be installed below the narrower Hub or Switch units.
- The unit must be connected to an earthed (grounded) outlet to comply with international safety standards.
- Do not connect the unit to an A.C. outlet (power supply) without an earth (ground) connection.
- The appliance coupler (the connector to the unit and not the wall plug) must have a configuration for mating with an EN 60320/IEC 320 appliance inlet.
- The socket outlet must be near to the unit and easily accessible. You can only remove power from the unit by disconnecting the power cord from the outlet.
- This unit operates under SELV (Safety Extra Low Voltage) conditions according to IEC 60950. The conditions are only maintained if the equipment to which it is connected also operates under SELV conditions.

France and Peru only

This unit cannot be powered from IT[†] supplies. If your supplies are of IT type, this unit must be powered by 230 V (2P+T) via an isolation transformer ratio 1:1, with

the secondary connection point labelled Neutral, connected directly to earth (ground).

† Impédance à la terre

Power Cord Set

This must be approved for the country where it will be used. e.g.

- U.S.A. and Canada
 - The cord set must be UL-approved and CSA certified.
 - The minimum specifications for the flexible cord are:
No. 18 AWG
Type SV or SJ
3-conductor
 - The cord set must have a rated current capacity of at least 10 A.
 - The attachment plug must be an earth-grounding type with a NEMA 5-15P (15 A, 125 V) or NEMA 6-15P (15 A, 250 V) configuration.
- Denmark
 - The supply plug must comply with Section 107-2-D1, Standard DK2-1a or DK2-5a.
- Switzerland
 - The supply plug must comply with SEV/ASE 1011.
- UK
 - The supply plug must comply with BS1363 (3-pin 13-amp) and be fitted with a 5 A fuse which complies with BS1362.
 - The mains cord must be <HAR> or <BASEC> marked and be of type HO3VVF3GO.75 (minimum).
- Europe
 - The supply plug must comply with CEE7/7 ("SCHUKO")
 - The mains cord must be <HAR> or <BASEC> marked and be of type HO3VVF3GO.75 (minimum).

L'INFORMATION DE SÉCURITÉ IMPORTANTE

Veillez lire à fond l'information de la sécurité suivante avant d'installer le Switch.



AVERTISSEMENT: L'installation et la dépose de ce groupe doivent être confiés à un personnel qualifié.

- Si vous entassez l'unité Switch avec les unités SuperStack II Hub, l'unité Switch doit être installée en dessous des unités Hub plus étroites.
- Ne branchez pas votre appareil sur une prise secteur (alimentation électrique) lorsqu'il n'y a pas de connexion de mise à la terre (mise à la masse).
- Vous devez raccorder ce groupe à une sortie mise à la terre (mise à la masse) afin de respecter les normes internationales de sécurité.
- Le coupleur d'appareil (le connecteur du groupe et non pas la prise murale) doit respecter une configuration qui permet un branchement sur une entrée d'appareil EN 60320/IEC 320.
- La prise secteur doit se trouver à proximité de l'appareil et son accès doit être facile. Vous ne pouvez mettre l'appareil hors circuit qu'en débranchant son cordon électrique au niveau de cette prise.
- L'appareil fonctionne à une tension extrêmement basse de sécurité qui est conforme à la norme IEC 60950. Ces conditions ne sont maintenues que si l'équipement auquel il est raccordé fonctionne dans les mêmes conditions.

France et Pérou uniquement:

Ce groupe ne peut pas être alimenté par un dispositif à impédance à la terre. Si vos alimentations sont du type impédance à la terre, ce groupe doit être alimenté par une tension de 230 V (2 P+T) par le biais d'un transformateur d'isolement à rapport 1:1, avec un point secondaire de connexion portant l'appellation Neutre et avec raccordement direct à la terre (masse).

Cordon électrique

Il doit être agréé dans le pays d'utilisation.

- États-Unis et Canada
 - Le cordon doit avoir reçu l'homologation des UL et un certificat de la CSA.
 - Le cordon souple doit respecter, à titre minimum, les spécifications suivantes:
calibre 18 AWG
type SV ou SJ
à 3 conducteurs
 - Le cordon doit être en mesure d'acheminer un courant nominal d'au moins 10 A.
 - La prise femelle de branchement doit être du type à mise à la terre (mise à la masse) et respecter la configuration NEMA 5-15P (15 A, 125 V) ou NEMA 6-15P (15 A, 250 V).
- Danemark:
 - La prise mâle d'alimentation doit respecter la section 107-2 D1 de la norme DK2 1a ou DK2 5a.
- Suisse:
 - La prise mâle d'alimentation doit respecter la norme SEV/ASE 1011.
- Europe
 - La prise secteur doit être conforme aux normes CEE 7/7 ("SCHUKO")
 - LE cordon secteur doit porter la mention <HAR> ou <BASEC> et doit être de type HO3VVF3GO.75 (minimum).

WICHTIGE SICHERHEITSINFORMATIONEN

Bitte unbedingt vor dem Einbauen des Switches die folgenden Sicherheitsanweisungen durchlesen.



WARNUNG: Die Installation und der Ausbau des Geräts darf nur durch Fachpersonal erfolgen.

- Wenn der Switch 2824/Switch 2816 mit anderen 3Com Hubs oder Switches gestapelt werden soll, müssen grössere Geräte unter den schmalere Hubs eingebaut werden.
- Das Gerät sollte nicht an eine ungeerdete Wechselstromsteckdose angeschlossen werden.
- Das Gerät muß an eine geerdete Steckdose angeschlossen werden, welche die internationalen Sicherheitsnormen erfüllt.
- Der Gerätestecker (der Anschluß an das Gerät, nicht der Wandsteckdosenstecker) muß einen gemäß EN 60320/IEC 320 konfigurierten Geräteeingang haben.

- Die Netzsteckdose muß in der Nähe des Geräts und leicht zugänglich sein. Die Stromversorgung des Geräts kann nur durch Herausziehen des Gerätenetzkabels aus der Netzsteckdose unterbrochen werden.
- Der Betrieb dieses Geräts erfolgt unter den SELV-Bedingungen (Sicherheitskleinstspannung) gemäß IEC 60950. Diese Bedingungen sind nur gegeben, wenn auch die an das Gerät angeschlossenen Geräte unter SELV-Bedingungen betrieben werden.

Stromkabel. Dies muss von dem Land, in dem es benutzt wird geprüft werden:

- Schweiz
 - Dieser Stromstecker muß die SEV/ASE 1011 Bestimmungen einhalten.
- Europe
 - Das Netzkabel muß vom Typ HO3VVF3GO.75 (Mindestanforderung) sein und die Aufschrift <HAR> oder <BASEC> tragen.
 - Der Netzstecker muß die Norm CEE 7/7 erfüllen ("SCHUKO").

TECHNICAL INFORMATION

Related Standards

The 3Com Switch 2824/3Com Switch 2816 has been designed to meet the following standards:

Functional	ISO 8802-3, IEEE 802.3 (Ethernet), IEEE 802.3u (Fast Ethernet), IEEE 802.3ab (Gigabit Ethernet), IEEE 802.3x (Flow control on full duplex links), IEEE 802.3d (Bridging), IEEE 802.1p (VLAN tagging/ priority queuing)
Safety	UL 60950, EN 60950, CSA 22.2 #60950, IEC 60950
EMC Emissions	EN 55022 Class A, FCC Part 15 Subpart B Class A, ICES-003 Class A, VCCI Class A, AS/NZS 3548 Class A, CNS 13438 Class A
Immunity	EN 55024

Environmental

Operating Temperature	0–45 °C (32–113 °F)
Humidity	10–95% (non-condensing)

Physical

Width	440 mm (17.3 in.)
Depth	173 mm (6.8 in.)
Height	43.6 mm (1.7 in.) or 1U
Weight	Switch 2824: 1.96 kg (4.32 lb) Switch 2816: 1.87 kg (4.12 lb)
Mounting	Free standing, or 19-inch rack mounted using the mounting kit supplied

Electrical

Power Inlet	IEC 320
AC Line Frequency	47 to 63 Hz
Input Voltage	100–240 VAC
Current Rating	0.4 A at 115 V, 0.2 A at 230 V
Maximum Power Consumption	Switch 2824: 45.7W Switch 2816: 36.5W
Maximum Power Dissipation	Switch 2824: 156 BTU/hr Switch 2816: 124.6 BTU/hr

REGULATORY NOTICES

FCC Statement

This equipment has been tested and found to comply with the limits for a Class A digital device, pursuant to part 15 of the FCC rules. These limits are designed to provide reasonable protection against harmful interference when the equipment is operated in a commercial environment. This equipment generates, uses and can radiate radio frequency energy and, if not installed and used in accordance with the instructions, may cause harmful interference to radio communications. Operation of this equipment in a residential area is likely to cause harmful interference to radio communications, in which case the user will be required to correct the interference at their own expense.

Information To The User

If this equipment does cause interference to radio or television reception, which can be determined by turning the equipment off and on, the user is encouraged to try to correct the interference by one or more of the following measures:

- Reorient the receiving antenna
- Relocate the equipment in relation to the receiver.
- Move the equipment away from the receiver.
- Plug the equipment into a different outlet so that equipment and receiver are on different branch circuits.

If necessary, the user should consult the dealer or an experienced radio/television technician for additional suggestions. The user may find the following booklet prepared by the Federal Communications Commission helpful:

How to Identify and Resolve Radio-TV Interference Problems

This booklet is available from the U.S. Government Printing Office, Washington,

DC 20402, Stock No. 004-000-00345-4.

In order to meet FCC emissions limits, this equipment must be used only with cables which comply with IEEE 802.3.

CE Statement (Europe)

This product complies with the European Low Voltage Directive 73/23/EEC and EMC Directive 89/336/EEC as amended by European Directive 93/68/EEC/.



Warning: *This is a Class A product. In a domestic environment, this product may cause radio interference in which case the user may be required to take adequate measures.*

CSA Statement

This Class A digital apparatus meets all requirements of the Canadian Interference-Causing Equipment Regulations.

Cet appareil numérique de la classe A respecte toutes les exigences du Règlement sur le matériel brouilleur du Canada.

VCCI Statement

この装置は、情報処理装置等電波障害自主規制協議会（VCCI）の基準に基づくクラスA情報技術装置です。この装置を家庭環境で使用すると電波妨害を引き起こすことがあります。この場合には使用者が適切な対策を講ずるよう要求されることがあります。

BSMI Statement

警告使用者：這是甲類的資訊產品，在居住的環境中使用時，可能會造成射頻干擾，在這種情況下，使用者會被要求採取某些適當的對策。

TECHNICAL SUPPORT

Where To Go For Help

Contact your authorized 3Com reseller or 3Com for additional product and support information. You will find support tools posted on the 3Com web site at www.3com.com

Register Your Product to Gain Service Benefits

To take advantage of warranty and other service benefits, you must first register your product at <http://eSupport.3com.com/> Services on eSupport are based on accounts that you create or have authorization to access. First time users must apply for an user name and password that provides access to a number of eSupport features including Product registration, Repair services, and Service request.

Troubleshoot Online

3Com knowledgebase, which contains thousands of technical solutions written by 3Com support engineers, helps you

troubleshoot 3Com products. This query-based interactive tool is located at: <http://knowledgebase.3com.com>

Purchase Value-Added Services

To enhance response times or extend warranty benefits, contact 3Com or your authorized reseller. Value-added services can include 24x7 telephone technical support, software upgrades, onsite assistance or advance hardware replacement. Experienced engineers are available to manage your installation with minimal disruption to your network. Expert assessment and implementation services are offered to fill resource gaps and ensure the success of your networking projects.

Contact Us

3Com offers telephone, e-mail, and internet access to technical support and repair services. To access these services for your region, use the appropriate telephone number, URL or e-mail address from the list below.

Telephone Technical Support and Repair

To obtain telephone support as part of your warranty and other service benefits, you must first register your product at <http://eSupport.3com.com/>

When you contact 3Com for assistance, please have the following information ready:

- | | |
|---|--|
| <ul style="list-style-type: none"> Product model name, part number, and serial number A list of system hardware and software, including rev level | <ul style="list-style-type: none"> Diagnostic error messages Details about recent configuration changes, if applicable |
|---|--|

Before you send a product directly to 3Com for repair, you must first obtain an authorization number. Products sent to 3Com without authorization numbers will be returned to the sender unopened, at the sender's expense.

If your product is registered and under warranty, you can obtain an RMA number online at <http://eSupport.3com.com/>

These numbers are correct at the time of publication. Find a current directory of support telephone numbers posted on the 3Com web site at <http://csoweb4.3com.com/contactus/>

Country	Telephone Number	Country	Telephone Number	Country	Telephone Number
Asia, Pacific Rim Telephone Technical Support and Repair					
Australia	1 800 678 515	New Zealand	0800 446 398	Singapore	800 6161 463
Hong Kong	800 933 486	Pakistan	+61 2 9937 5083	S. Korea	080 333 3308
India	+61 2 9424 5179 or 000800 650 1111	Philippines	1235 61 266 2602 or +61 2 9937 5076	Taiwan	00801 611 261
Indonesia	001 803 61009	P.R. of China	10800 61 00137 or 021 6350 1590 or 00800 0638 3266	Thailand	001 800 611 2000
Japan	00531 616 439 or 03 5977 7991				

You can also obtain support for this region using the following e-mail: apr_technical_support_@3com.com
Or request a repair authorization number (RMA) by fax using this number: +65 543 6348

Europe, Middle East and Africa Telephone Technical Support and Repair

From anywhere in these regions, call: +44 (0)1442 435529
From the following countries, you may use the numbers shown:

Austria	01 7956 7124	Ireland	01407 3387	Portugal	707 200 123
Belgium	070 700 770	Israel	1800 945 3794	South Africa	0800 995 014
Denmark	7010 7289	Italy	199 161346	Spain	9 021 60455
Finland	01080 2783	Luxembourg	342 0808128	Sweden	07711 14453
France	0825 809 622	Netherlands	0900 777 7737	Switzerland	08488 50112
Germany	01805 404 747	Norway	815 33 047	U.K.	0870 241 3901
Hungary	06800 12813	Poland	00800 441 1357		

You can also obtain support for this region from the following URL: <http://emea.3com.com/support/email.html>

Latin America Telephone Technical Support and Repair

Antigua	1 800 998 2112	Chile	AT&T +800 998 2112	Mexico	01 800 849CARE
Argentina	0 810 444 3COM	Colombia	AT&T +800 998 2112	Nicaragua	AT&T +800 998 2112
Aruba	1 800 998 2112	Costa Rica	AT&T +800 998 2112	Panama	AT&T +800 998 2112
Bahamas	1 800 998 2112	Curacao	1 800 998 2112	Paraguay	54 11 4894 1888
Barbados	1 800 998 2112	Ecuador	AT&T +800 998 2112	Peru	AT&T +800 998 2112
Belize	52 5 201 0010	Dominican Republic	AT&T +800 998 2112	Puerto Rico	1 800 998 2112
Bermuda	1 800 998 2112	Guatemala	AT&T +800 998 2112	Salvador	AT&T +800 998 2112
Bonaire	1 800 998 2112	Haiti	57 1 657 0888	Trinidad and Tobago	1 800 998 2112
Brazil	0800 13 3COM	Honduras	AT&T +800 998 2112	Uruguay	AT&T +800 998 2112
Cayman	1 800 998 2112	Jamaica	1 800 998 2112	Venezuela	AT&T +800 998 2112
		Martinique	571 657 0888	Virgin Islands	57 1 657 0888

Spanish speakers can also obtain support for this region from the following URL: <http://lat.3com.com/lat/support/form.html>
Portuguese speakers can also obtain support for this region from the following URL: <http://lat.3com.com/br/support/form.html>
English speaker in Latin America should send e-mail for support to: lat_support_anc@3com.com

North America Telephone Technical Support and Repair

1 800 876 3266

LEGAL NOTICES

© 3Com Technologies, 2003. All rights reserved. No part of this documentation may be reproduced in any form or by any means or used to make any derivative work (such as translation, transformation, or adaptation) without permission from 3Com Technologies.

3Com Technologies reserves the right to revise this documentation and to make changes in content from time to time without obligation on the part of 3Com Technologies to provide notification of such revision or change.

3Com Technologies provides this documentation without warranty of any kind, either implied or expressed, including, but not limited to, the implied warranties of merchantability and fitness for a particular purpose. 3Com may make improvements or changes in the product(s) and/or the program(s) described in this documentation at any time.

UNITED STATES GOVERNMENT LEGENDS:

If you are a United States government agency, then this documentation and the software described herein are provided to you subject to the following restricted rights:

For units of the Department of Defense:

Restricted Rights Legend: Use, duplication or disclosure by the Government is subject to restrictions as set forth in subparagraph (c) (1) (ii) for restricted Rights in Technical Data and Computer Software clause at 48 C.F.R. 52.227-7013. 3Com Centre, Boundary Way, Maylands Park South, Hemel Hempstead, Herts, HP2 7YU, U.K.

For civilian agencies:

Restricted Rights Legend: Use, reproduction or disclosure is subject to restrictions set forth in subparagraph (a) through (d) of the Commercial Computer Software - Restricted Rights Clause at 48 C.F.R. 52.227-19 and the limitations set forth in 3Com Corporation's standard commercial agreement for the software. Unpublished rights reserved under the copyright laws of the United States.

If there is any software on removable media described in this documentation, it is furnished under a license agreement included with the product as a separate document, in the hard copy documentation, or on the removable media in a directory file named LICENSE.TXT. If you are unable to locate a copy, please contact 3Com and a copy will be provided to you.

Unless otherwise indicated, 3Com registered trademarks are registered in the United States and may or may not be registered in other countries.

3Com and SuperStack are registered trademarks of 3Com Corporation.

IEEE and 802 are registered trademarks of the Institute of Electrical and Electronic Engineers, Inc.

Other brand and product names may be registered trademarks or trademarks of their respective holders.

ENVIRONMENTAL STATEMENTS

General Environmental Statement

It is the policy of 3Com Corporation to be environmentally-friendly in all operations. To uphold our policy, we are committed to:

- Establishing environmental performance standards that comply with national legislation and regulations
- Conserving energy, materials and natural resources in all operations
- Reducing the waste generated by all operations
- Ensuring that all waste conforms to recognized environmental standards
- Maximizing the recyclable and reusable content of all products
- Ensuring that all products can be recycled, reused and disposed of safely
- Ensuring that all products are labelled according to recognized environmental standards
- Improving our environmental record on a continual basis

End Of Life Statement

3Com processes allow for the recovery, reclamation and safe disposal of all end-of-life electronic components.

Regulated Materials Statement

3Com products do not contain any hazardous or ozone-depleting material.

Environmental Statement about the Documentation

The documentation for this product is printed on paper that comes from sustainable, managed forests; it is fully biodegradable and recyclable, and is completely chlorine-free. The varnish is environmentally-friendly, and the inks are vegetable-based with a low heavy-metal content.

Documentation Feedback

Your suggestions are very important to us. They will help make our documentation more useful to you. Please e-mail comments about this document to 3Com at:

pddtechpubs_comments@3Com.com

Please include the following information when commenting: the document title, part number (shown at the bottom of this page), and page number, if appropriate.